



NEW!

“PoE Plus” Magnetics

The **ETH1-230L₁** is developed for high power PoE applications in support of the goals of the IEEE 802.3 “at” working group. This module is designed for 2-pair cabling plants at 30 Watts and two modules may be used for 4-pair cabling in 60 Watt applications. It exceeds the return loss requirements of Gbit Ethernet.

It has a minimum open-circuit inductance of 350 μ H at an offset current of 35 mA at 25°C ambient temperature, and can handle 22.5 mA minimum dc offset at 85°C. Typical temperature rise from 25°C ambient is 7°C with 800 mA and 10°C with 1000 mA dc current applied. Winding to winding isolation is 1500 Vrms. Ambient temperature range: -40°C to +85°C with 1 A current.

1. When ordering, please specify **packaging** code:

ETH1-230LD

Packaging: **D** = 13” machine-ready reel. EIA-481 embossed plastic tape. Factory order only, not stocked (400 parts per full reel).

B = Less than full reel. In tape, but not machine ready. To have a leader and trailer added (\$25 charge), use code letter D instead.

Request free evaluation samples by contacting Coilcraft or visiting www.coilcraft.com.

L vs Offset Current

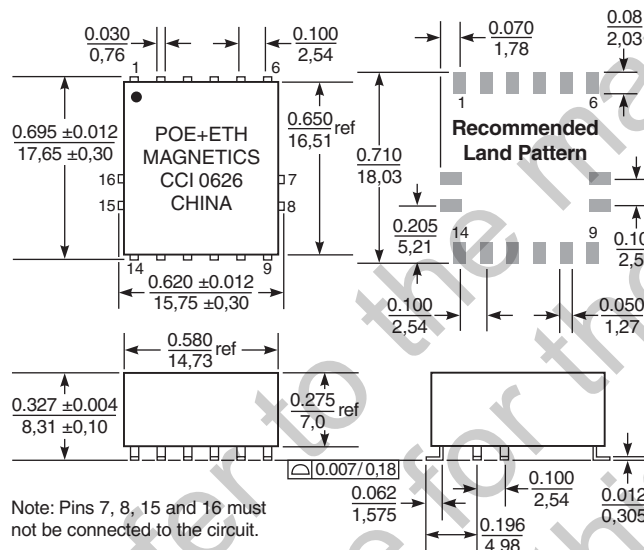
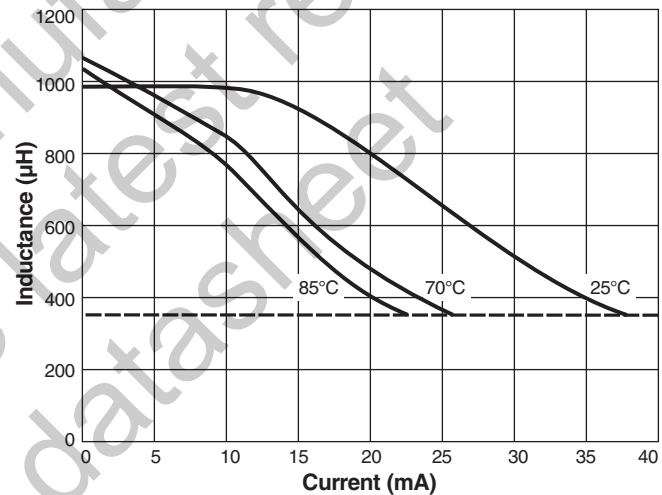

Weight: 3.0 g
Tape and reel: 400/13” reel 32 mm tape

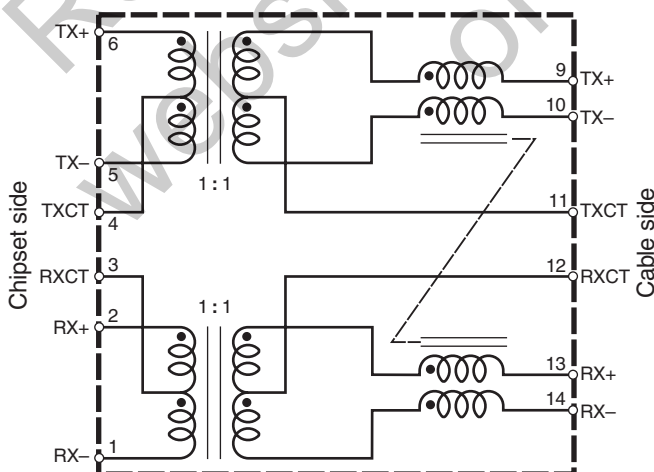

Return Loss

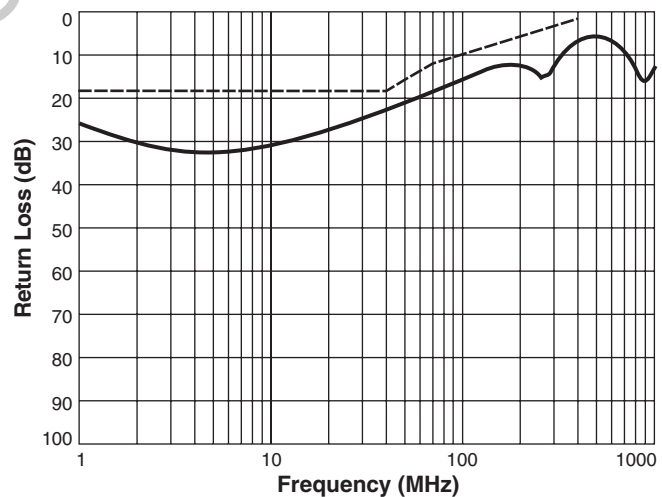

802.3af specification:
 18 dB min from 1 MHz to 40 MHz
 16 dB min at 50 MHz
 12 dB min at 80 MHz
 10 dB min at 100 MHz



Specifications subject to change without notice. Please check our website for latest information.

Document 538-1 Revised 04/06/07

1102 Silver Lake Road Cary, Illinois 60013 Phone 847/639-6400 Fax 847/639-1469

E-mail info@coilcraft.com Web <http://www.coilcraft.com>



NEW!

“PoE Plus” Magnetics

Insertion Loss

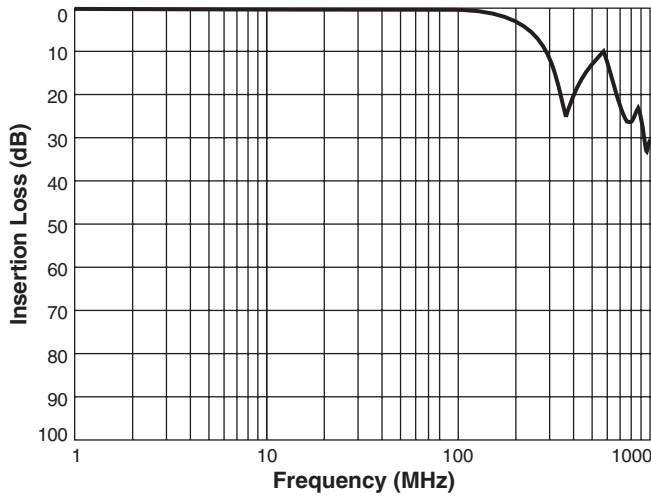

802.3af specification:
 1.0 min dB from 0.1 MHz to 100 MHz
 1.2 min dB at 125 MHz

Crosstalk

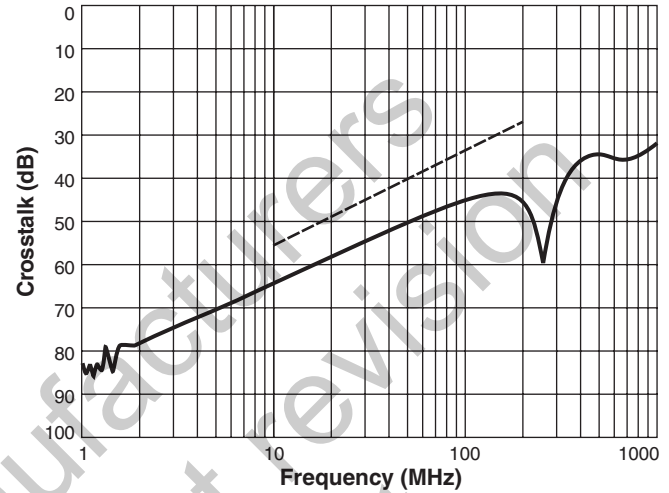

802.3af specification:
 45 dB min at 30 MHz
 40 dB min at 60 MHz
 33 dB min at 100 MHz

Common Mode Rejection

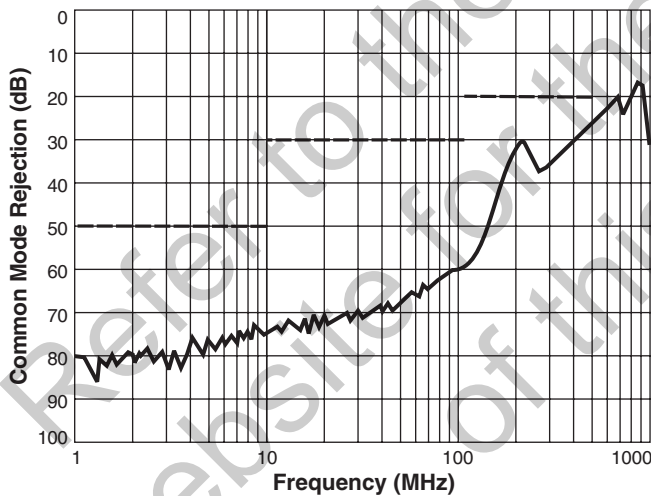

802.3af specification:
 50 dB min from 1 MHz to 10 MHz
 30 dB min from 10 MHz to 125 MHz
 20 dB min from 125 MHz to 500 MHz

Differential to Common Mode Rejection

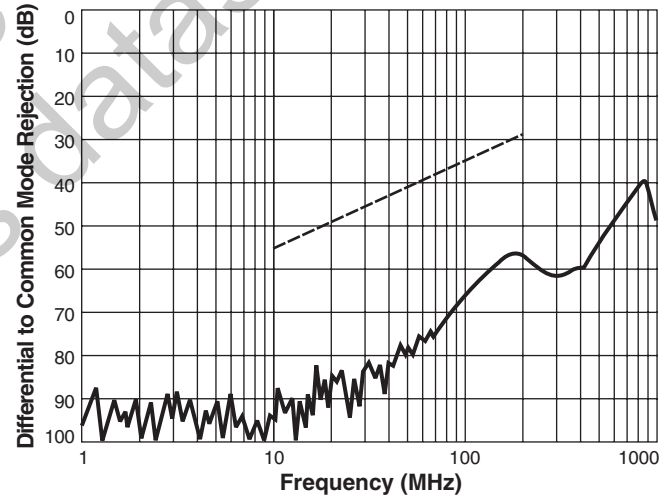

802.3af specification:
 45 dB min at 30 MHz
 40 dB min at 60 MHz
 35 dB min at 100 MHz



Specifications subject to change without notice.
 Please check our website for latest information.

Document 538-2 Revised 04/06/07

1102 Silver Lake Road Cary, Illinois 60013 Phone 847/639-6400 Fax 847/639-1469

E-mail info@coilcraft.com Web <http://www.coilcraft.com>